

# Maxi Marine Accu - MMA

80-10 000 l.

EN



SAFETY INFORMATION  
O&M INFORMATION  
INSTALLATION MANUAL

**Manufactured by OSO Hotwater AS**  
Industriveien 1 - 3300 Hokksund - Norway  
Tel: + 47 32 25 00 00 / E-mail: oso@oso.no  
www.osohotwater.com

11002356-02 - 04-2024

**OSO**  
HOT WATER

# CONTENTS

<b>1. Safety instructions</b> .....	3
1.1 General information.....	3
1.2 Safety instructions for users.....	4
1.3 Safety instructions for installers.....	4
<b>2. Product description</b> .....	5
2.1. Product identification.....	5
2.2. Intended use.....	5
2.3 CE marking.....	5
2.4 Technical data.....	5
<b>3. Instructions for installation, operation and maintenance</b> .....	6
3.1. Products covered by these instructions.....	6
3.2. Specs and installation.....	6
<b>4. Delivery and location</b> .....	7
4.1 Delivery.....	7
4.2 Requirements for installation, location and positioning.....	7
4.3 Pipe installation.....	8
4.4 Installation, operation and maintenance.....	8
4.5 Electrical installation (optional - MMA Heat only).....	8
4.6 Handover to end user.....	12
4.7 Contact details - installer.....	12
<b>5. Initial commissioning</b>	
5.1 Filling with water.....	13
5.2 Turning on the power.....	13
5.3 Control points.....	13
5.4 Emptying of water.....	13
5.5 Handover to end-user.....	13
<b>6. User guide</b> .....	14
6.1 Settings.....	14
6.2 Maintenance.....	14
<b>7. Warranty conditions</b> .....	15
7.1. Customer service.....	15
<b>8. Removing the product</b> .....	15
8.1. Removal.....	15
8.2. Returns scheme.....	15

# 1. SAFETY INSTRUCTIONS

## 1.1 General information

- Read the following safety instructions carefully before installing, maintaining or adjusting the product.
- Personal injury or material damage may result if the product is not installed or used in the intended manner.
- Keep this manual and other relevant documents where they are accessible for future reference.
- The manufacturer assumes compliance (by the end-user) with the safety, operating and maintenance instructions supplied and (by the installer) with the fitting manual and relevant standards and regulations in effect at the date of installation.
- Ensure installation is in compliance with the applicable class rules.

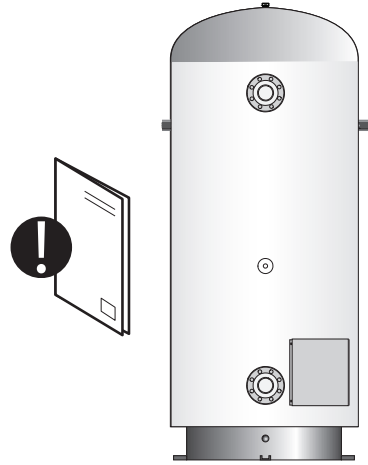

Symbols used in this manual:

	WARNING	Could cause serious injury or death
	CAUTION	Could cause minor or moderate injury or damage to property
	DO NOT	
	DO	

## 1.2 Safety instructions for users

⚠ WARNING	
⊘	The overflow from any safety valve shall NOT be sealed or plugged.
⊘	The product must NOT be modified or changed from its original state.
⊘	Children must NOT play with the product or go near it without supervision.
❗	Maintenance/settings shall only be carried out by persons over 18 years of age, with sufficient understanding

⚠ CAUTION	
⊘	The product must not be exposed to frost, over-pressure, over-voltage or chlorine treatment. See warranty provisions.
⊘	Maintenance/settings shall not be carried out by persons of diminished physical or mental capacity, unless they have been instructed in the correct use by someone responsible for their safety.

## 1.3 Safety instructions for installers

⚠ WARNING	
⊘	The overflow from any safety valve shall NOT be sealed or plugged.
❗	Any discharge pipe from the safety valve MUST be of a suitable dimension, fitted uninter-ruptable, undamaged and frost-free with a fall to a suitable drain or gulley.
❗	The relevant regulations and standards, and this installation manual, must be followed.

⚠ CAUTION	
❗	The product shall be placed in a room with a drain. Alternatively, fit an automatic stop valve with sensor and a discharge pipe from the safety valve overflow to a suitable drain or gulley. Liability for consequential damage will only apply if this is followed.
❗	The product shall be properly aligned vertically and horizontally, on a floor suitable for the total weight of the product when in operation. See type plate.
❗	The product must have a clearance for servicing of 40 cm in front of the electric junction box cover (if fitted) and front connections / 10 cm. above the highest point.

MANUFACTURER NOTIFICATION
The products shown in this manual is equipped with a standard nozzle layout. The products can however be designed entirely to customer specifications, and the product that is supplied with this manual may be specified with a different lay-out than the illustrations in the manual.

## 2. PRODUCT DESCRIPTION

### 2.1 Product identification

Identification details for your product can be found on the type plate fixed to the product. The type plate contains details of the product in accordance with EN 60335-2-21 as well as other useful data. See Declaration of Conformity at [www.osohotwater.com](http://www.osohotwater.com) for more information.

OSO products are designed and manufactured in accordance with:

- Pressurized equipment PED 2014/68/EU
- Safety standard EN 60335-2-21\*

OSO Hotwater AS is certified for

- Quality ISO 9001
- Environment ISO 14001
- Work environment ISO 45001
- Welding standard EN ISO 3834-2

### 2.2 Intended use

The Maxi Marine Accu is designed for use as a buffer tank for heat pumps/solar collectors, or in cooling systems etc. MMA Heat accumulators can be fitted with electric immersion heaters (optional).

### 2.3 CE marking



The CE mark shows that the product complies with the relevant Directives. See Declaration of Conformity at [www.osohotwater.com](http://www.osohotwater.com) for more information.

The product complies with EU Directives for:

- Low voltage LVD 2014/35/EU
- Electromagnetic compatibility EMC2014/30/EU
- Pressurized equipment PED 2014/68/EU

Any safety valve(s) used must be CE marked and conform to PED 2014/68/EU.

### 2.4 Technical Data (standard products)

Prod. No.	Product code:	IP class*	Weight kg.	Dia x height mm.	Freight vol. m <sup>3</sup>	Actual vol. L
	Maxi Marine Accu Cool - MMA 80	NA	50	Ø580x635	0.34	78
	Maxi Marine Accu Cool - MMA 120	NA	58	Ø580x827	0.34	111
11003438	Maxi Marine Accu Cool - MMA 200	NA	82	Ø580x1257	0.54	193
11003431	Maxi Marine Accu Cool - MMA 300	NA	103	Ø580x1707	0.71	279
11003432	Maxi Marine Accu Cool - MMA 400	NA	129	Ø580x2197	0.87	373
11003434	Maxi Marine Accu Cool - MMA 600	NA	169	Ø780x1916	3.39	532
11003435	Maxi Marine Accu Cool - MMA 750	NA	227	Ø980x1833	3.39	755
11003436	Maxi Marine Accu Cool - MMA 1000	NA	252	Ø980x2083	3.39	878
11003437	Maxi Marine Accu Cool - MMA 1500	NA	Subject to customer specification			
	Maxi Marine Accu Cool - MMA 2000	NA	Subject to customer specification			
11003439	Maxi Marine Accu Cool - MMA 3000	NA	Subject to customer specification			
11003440	Maxi Marine Accu Cool - MMA 5000	NA	Subject to customer specification			
	Maxi Marine Accu Cool - MMA 10 000	NA	Subject to customer specification			
	Maxi Marine Accu Heat - MMA 80	IP21	50	Ø580x635	0.34	78
	Maxi Marine Accu Heat - MMA 120	IP21	58	Ø580x827	0.34	111
	Maxi Marine Accu Heat - MMA 200	IP21	82	Ø580x1257	0.54	193
11003442	Maxi Marine Accu Heat - MMA 300	IP21	103	Ø580x1707	0.71	279
11003443	Maxi Marine Accu Heat - MMA 400	IP21	129	Ø580x2197	0.87	373
11003445	Maxi Marine Accu Heat - MMA 600	IP21	169	Ø780x1916	3.39	532
11003446	Maxi Marine Accu Heat - MMA 750	IP21	227	Ø980x1833	3.39	755
11003447	Maxi Marine Accu Heat - MMA 1000	IP21	252	Ø980x2083	3.39	878
11003448	Maxi Marine Accu Heat - MMA 1500	IP21	Subject to customer specification			
11003449	Maxi Marine Accu Heat - MMA 2000	IP21	Subject to customer specification			
11003450	Maxi Marine Accu Heat - MMA 3000	IP21	Subject to customer specification			
11003451	Maxi Marine Accu Heat - MMA 5000	IP21	Subject to customer specification			
	Maxi Marine Accu Heat - MMA 10 000	IP21	Subject to customer specification			
Regulation: 2017/1369/EU - Regulation: EU 812/2013		Directive: 2009/125/EC - Regulation: EU 814/2013				

\*Applies only to products fitted with electric immersion heaters (option for Triton Marine Accu Heat accumulators only).

### 3. INSTRUCTIONS FOR INSTALLATION, OPERATION AND MAINTENANCE

#### 3.1 Products covered by these instructions:

Maxi Marine Accu Heat - MMA Heat 80-10 000

Maxi Marine Accu Cool - MMA Cool 80-10 000

#### 3.2 Specs and installation

The OSO Maxi Marine Accu series is manufactured to customer specifications. Pipe connections and general design layout, including electric equipment such as immersion heaters (in Maxi Marine Accu Heat configuration) is specified individually for each product in collaboration between the customer and OSO.

The Maxi Marine Accu Heat accumulator can be specified with a variety of electric junction box layouts (1) as an option. The Maxi Marine Accu Cool accumulator can not be fitted with an electric junction box.

This manual shows the basic standard layout of the Maxi Marine Accu series. Additional features and fixtures (including electrical components and circuit diagrams for heat accumulators) will be described in separate documents supplied with the product if added.

The Maxi Marine Accu Heat series is supplied with mineral wool insulation as standard.

The Maxi Marine Accu Cool series is supplied with a diffusion safe rubber cell insulation as standard to avoid condensation.

Installation of the product must be in accordance with relevant current standards and regulations.

##### 3.2.1 Installer contact details

The installer must fill in contact details in table on page 13 before handover to end user (pt. 4.8).

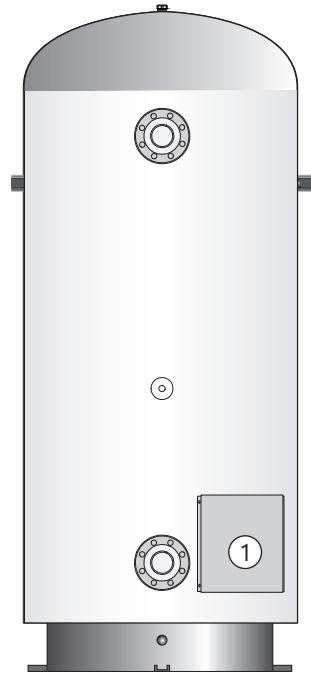

MMA Heat

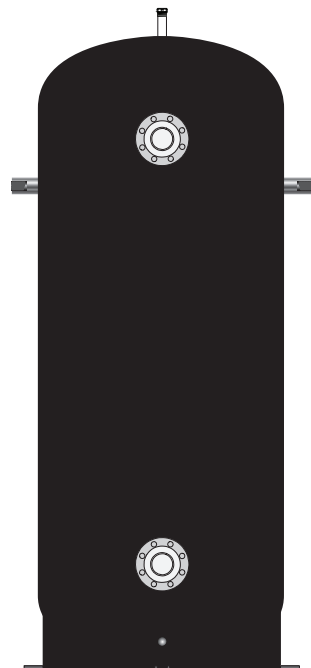

MMA Cool

## 4. DELIVERY AND LOCATION

### 4.1 Delivery

The product should be transported carefully to its designated location, with packaging.

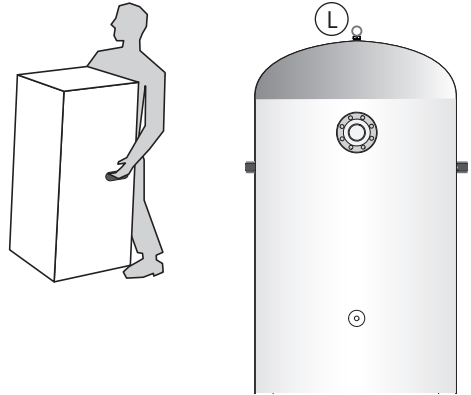

#### ⚠ CAUTION

Pipe stubs, valves etc. should not be used to lift the product as this could cause malfunctions. Products larger than 400 l. are fitted with a lifting lug (L), see illustration. Specific lifting instructions are supplied with the product.

### 4.2 Requirements for installation, location and positioning

#### ⚠ CAUTION

❗	The product shall be placed in a room with a drain. Alternatively, fit an automatic stop valve with sensor and a discharge pipe from the safety valve overflow to a suitable drain or gully. Liability for consequential damage will only apply if this is followed.
❗	The product shall be placed in a dry and permanently frost-free position.
❗	The product shall be placed on a floor suitable for the total weight of the product when in operation. See type plate.
❗	The product must have a clearance for servicing of 40 cm in front of the electric junction box cover (if fitted) and front connections / 10 cm. above the highest point.
❗	The product shall be easily accessible for servicing and maintenance.

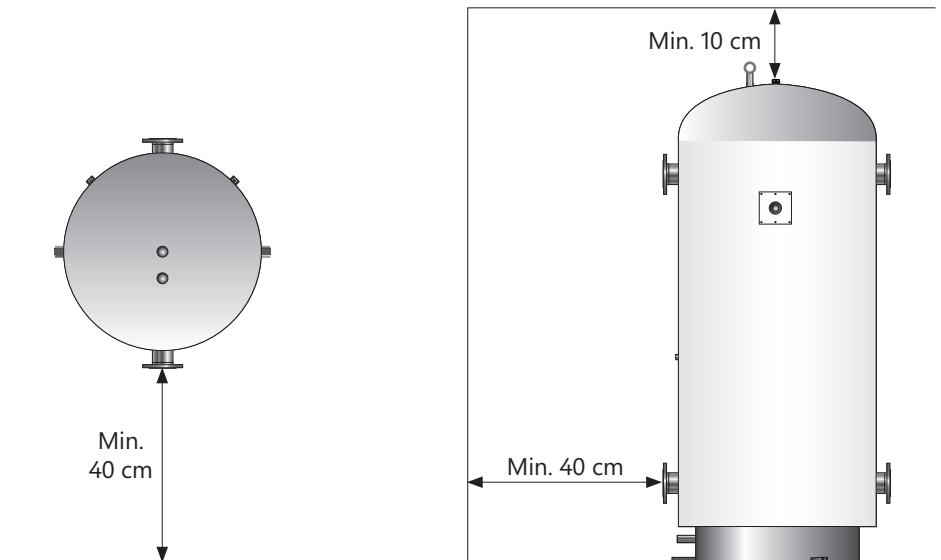

## 4.3 Pipe installation

### 4.3.1 Nozzles

No.	Dimension	Connection description
1	To order	Lifting lug
2	3/4-1" internal thread.	Venting (not 80-400 l.)
3	To order	Flow/Return
4	1/2" int. thread	Thermometer / sensor
5	To order	Flow/Return
6	To order	Drain

All nozzles are open to customer specifications.

## 4.4 Installation, operation and maintenance

The vessel is factory fitted with wall and floor mounting brackets (A) and (B). The brackets shall be used to ensure safe installation.

### 4.4.1 Filling the vessel

Connect flow and return pipes, open water supply. If desired stop valves can be added to flow and return pipes (not supplied). Vent vessel through venting nozzle (1) during filling. When vessel is full, plug venting nozzle (1). Volumes 80-400 l. must be vented through a hot water tap or similar.

When the system is pressurized, check all pipe connection for leaks. Tighten if necessary. All connections should be re-checked after approx. 3 months of service, then annually.

### 4.4.2 Operation

The vessel is designed for water storage and circulation, and once fitted there are no operational demands.

### 4.4.3 Maintenance

The vessel requires no specific maintenance, but it is recommended to check all pipe connections for leaks annually to avoid unwanted water spillage or damage to the vessel or its surroundings.

### 4.4.4 Important

Follow the instructions for use and operation. The vessel can be designed for a max. operating pressure of 6 bar. Test pressure 15 bar.

### 4.4.5 Draining the vessel

Turn off water supply. Drain the vessel through the lower flow/return connection (5) or by using the drain nozzle (6) (1500 l. and bigger). Open venting nozzle (1) to avoid vacuum and aid draining speed.

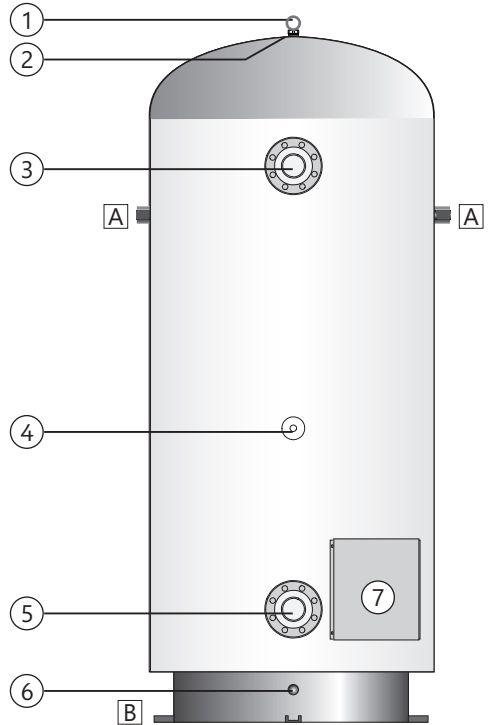

## 4.5 Electrical installation (optional - MMA Heat)

Fixed electrical fittings must be used for installation. Any electric fittings must be installed by an authorized electrician. Relevant standards and regulations must be followed.

### 4.5.1 Electrical components (standard)

Component	Note
Safety thermostat	85°C thermal cut-out
Work thermostat	Adjustable 50-75°C
Heating element	3-phase 230-480 V
Internal wires	Heat-resistant

### 4.5.2 Electrical connections in the junction box (option in MMA Heat only)

Note: The description below is for a standard junction box. The product can be fitted with customer spec junction box(es) with other connection requirements. Check separate documents if supplied.

A) Supply cable connected to terminal (8) as shown. Supply wires should be secured with suitable strain relievers.

B) Internal wires from connection terminal (8) to thermostats and the wires from thermostats



to elements are pre-connected from the factory.

- C) Make sure that the earth wire (yellow wire with green stripe) is connected to the earthing point (⊕)

The Junction box cover (7) shall be correctly fitted before the power is switched on.

### 4.5.3 Wiring diagram

Junction box with 3 elements. Max. voltage 480V. Possible power output variations:

Power input	Power output
3x230V	4.05 kW (3x1.35 kW)
3x380V	11.1 kW (3x3.7 kW)
3x400V	12.3 kW (3x4.1 kW)
3x415V	13.2 kW (3x4.4 kW)
3x440V	15 kW (3x5 kW)
3x460V	16.5 kW (3x5.5 kW)
3x480V	17.6 kW (3x5.9 kW)

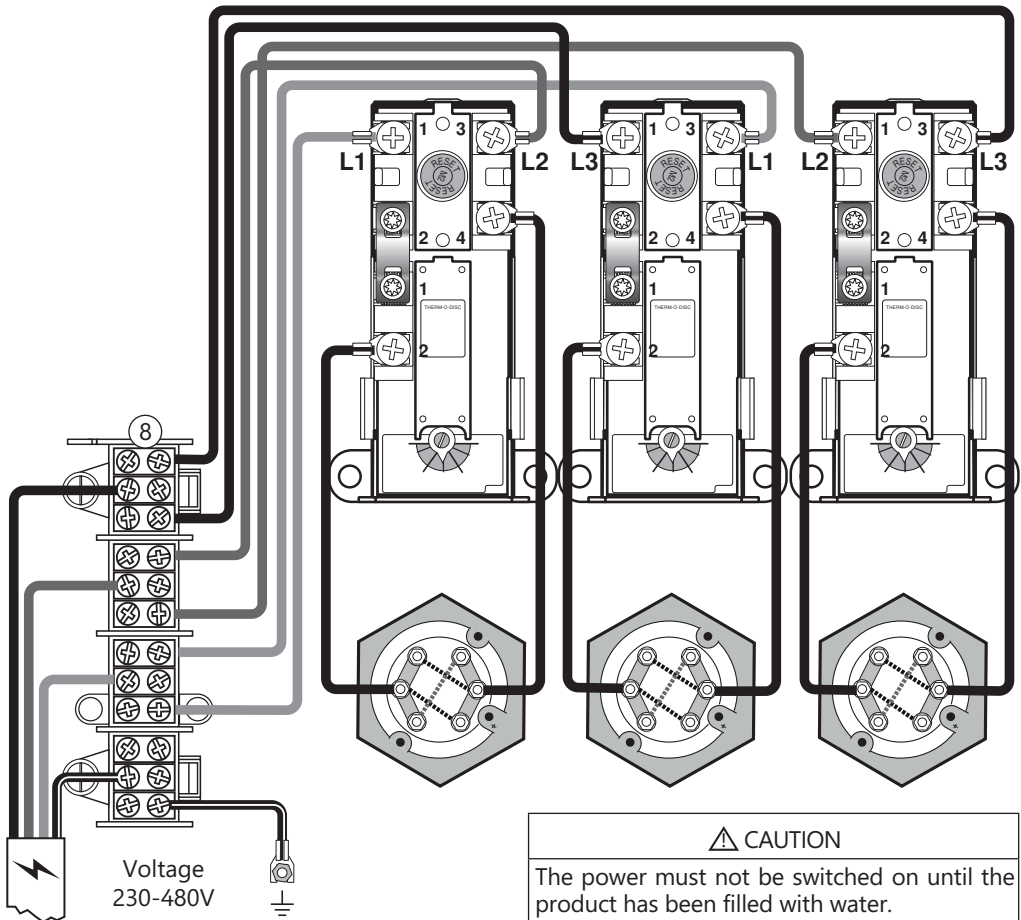

### 4.5.4 Torque settings - std. junction box

Component	Torque
G1 1/4" - 1 1/2" heating element	60 Nm (+/- 5)
Thermostat screws	2 Nm (+/- 0.1)
Screw on the element head	2 Nm (+/- 0.1)
Screw on connection piece (5)	2 Nm (+/- 0.1)

**⚠ WARNING**

Constant voltage is present at the terminals. Before any electrical work is done, the power supply must be disconnected and secured against activation while the work is in progress.

#### 4.5.5 Wiring diagram

Junction box with 6 elements. Max. voltage 480V. Supply cable is connected to terminal (5) as shown. Supply wires shall be secured with suitable strain relievers.

Possible power output variations:

Power input	Power output
3x230V	8.1 kW (6x1.35 kW)
3x380V	22.2 kW (6x3.7 kW)
3x400V	24.6 kW (6x4.1 kW)
3x415V	26.4 kW (6x4.4 kW)
3x440V	30 kW (6x5 kW)
3x460V	33 kW (6x5.5 kW)
3x480V	35.4 kW (6x5.9 kW)

#### ⚠ WARNING

Constant voltage is present at the terminals. Before any electrical work is done, the power supply must be disconnected and secured against activation while the work is in progress.

#### 4.5.6 Torque settings - std. junction box

Component	Torque
G 1.1/4" - 1.1/2" heating element	60 Nm (+/- 5)
Thermostat screws	2 Nm (+/- 0.1)
Screw on the element head	2 Nm (+/- 0.1)

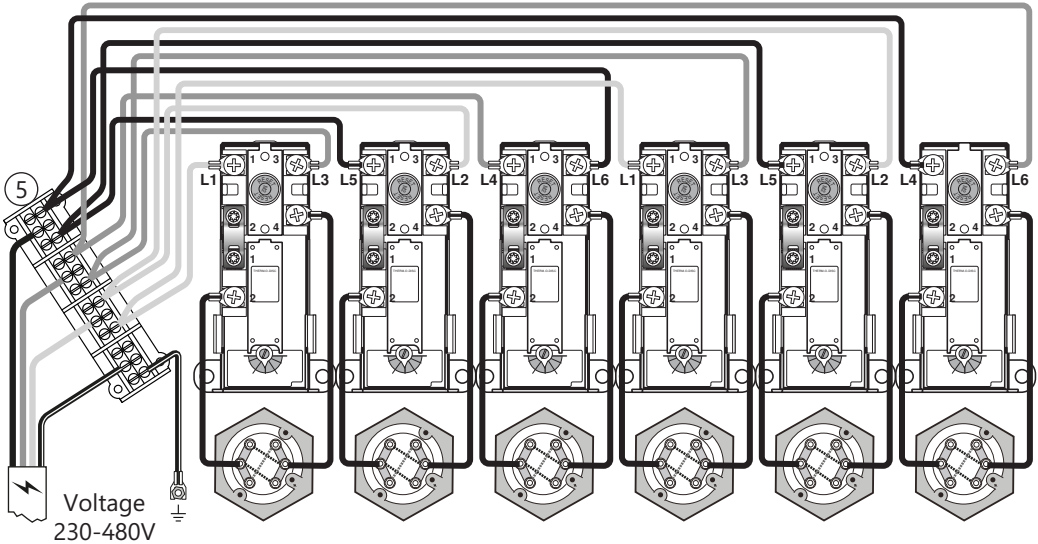

#### 4.5.7 Wiring diagram - K12 terminal box

The K12 terminal box is approved for installation in boilers designed for heating of water. It is possible to fit multiple K12 terminal boxes in one boiler, each with a separate power supply.

The electric terminal box is fitted with a 5-pole terminal block 4 mm<sup>2</sup>, a 3-pole temperature limiter (t2) 102°C with manual reset and a 1-pole thermostat (t1) 30-90°C.

A bag containing 2 fastener screws for the box is supplied inside the terminal box, along with a steel rail for the thermostat pocket in the heat-

ing element, along with jumpers and connection materials for electric connection of the heating element.

If the power cable to the K12 terminal box is fitted where the surrounding temperature exceeds +75°C the electrical connection must be done using a power cable approved for the surrounding temperature range. The surrounding temperature of the K12 element MUST NOT exceed 50°C.

The K12 terminal box shall not be exposed to excessive heat radiation, such as near a boiler or furnace for solid fuels with a door where bare

flames can appear when stoking.

**Important:**

1. The K12 terminal box must be fitted by an authorised electrician.
2. Electrical connection must be performed in accordance with the wiring diagram supplied inside the electric terminal box as well as current laws and regulations.
3. The K12 terminal box power supply must be fed through an all-pole switch which is to be installed in the power supply circuit.

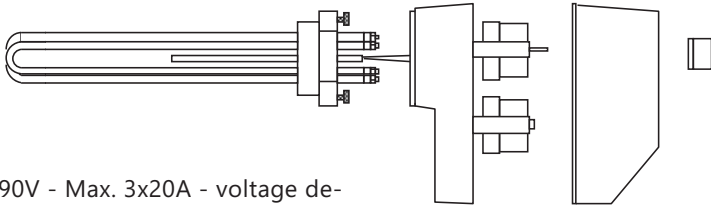

Effect 230 / 690V - Max. 3x20A - voltage depending on element type.

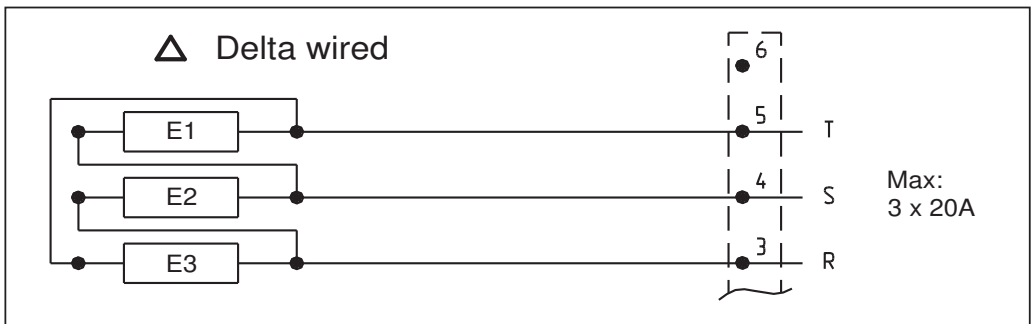
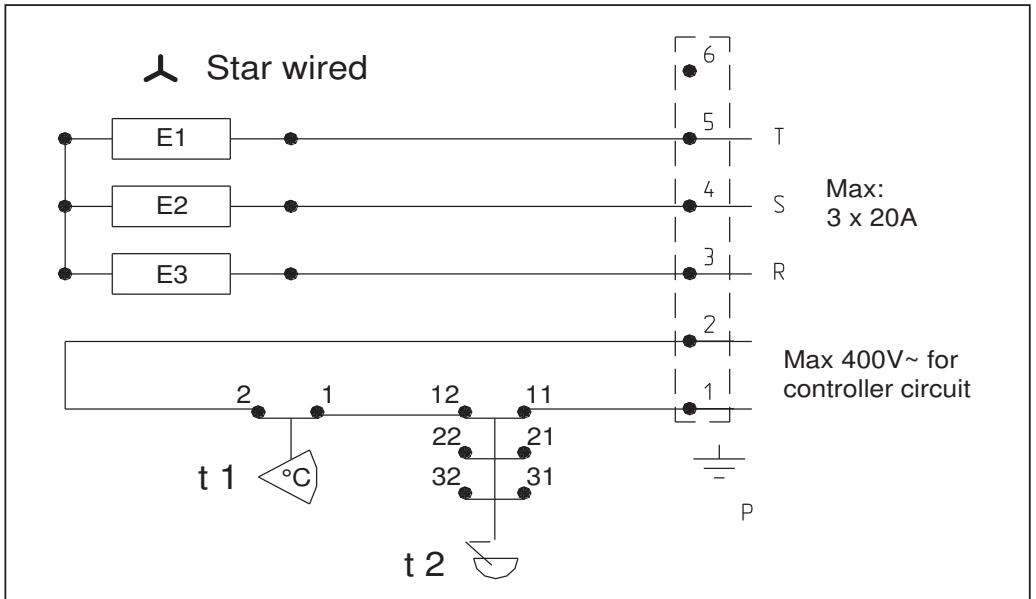

#### 4.5.8 Fitting instructions

⚠ WARNING	
❗	The product must be filled with water before the power is switched on.
❗	Fixed electrical fittings must be used for installation according to the regulations. Any electric fittings must be installed by an authorised electrician.
❗	The mains cable shall withstand 90°C. A suitable strain reliever must be fitted.

⚠ CAUTION	
❗	The product must have a clearance for servicing of 40 cm in front of the junction box cover.
❗	In case of damage to the power supply cable it shall be replaced with new cable with the correct specifications for the installation. All electrical work should be performed by an authorised electrician.

RECOMMENDATION	
-	An authorised electrician shall calculate the correct supply cable and fuse according to the applicable standards and regulations.

#### 4.6 Handover to end-user

THE INSTALLER MUST:	
❗	Brief the end-user on safety and maintenance instructions.
❗	Brief the end-user on settings and emptying the product.
❗	Hand this installation manual over to the end-user.
❗	Enter contact details in the contact information table on page 6.

#### 4.7 Contact details - installer

CONTACT INFORMATION	
<b>Installed by (company):</b>	
<b>Company address:</b>	
<b>Company telephone:</b>	
<b>Company email:</b>	
<b>Installer name:</b>	
<b>Installation date:</b>	

## 5. INITIAL COMMISSIONING

### 5.1 Filling with water

First check that all pipes are connected correctly. Then fill the tank according to the needs/requirements of the system. Make sure that the tank is vented during filling to prevent air pockets.

### 5.2 Turning on the power

When the cylinder has been filled with water, the power can be switched on (if fitted):

A) Switch on breaker/fuse.

### 5.3 Control points

A) Check that all pipe connections to/from the product are tight and not leaking.

B) Check that the power supply to the product (if fitted) is not at risk of exposure to mechanical, thermal or chemical damage.

C) Check that any overflow pipe from the safety valve is clear, undamaged and frost-free with a fall to the drain.

D) Check that the product is standing firmly vertically and horizontally.

### 5.4 Emptying of water

<b>⚠ WARNING</b>
The water temperature in the product is 75°C and could cause scalding. Before emptying, a hot tap shall be opened to the max. pressure/temperature for min. 3 minutes.

A) Disconnect the power supply (if fitted).

B) Shut off incoming cold water supply.

C) Open a hot tap to the maximum  
– leave open (prevents vacuum).

D) The product is emptied using the drain (1).

After emptying, close the drain (1). Close all open taps.

### 5.5 Handover to end-user

<b>THE INSTALLER MUST:</b>
Brief the end-user on safety and maintenance instructions.
Brief the end-user on settings and emptying the product.
Hand this installation manual over to the end-user.
Enter contact details on the type plate on the product.

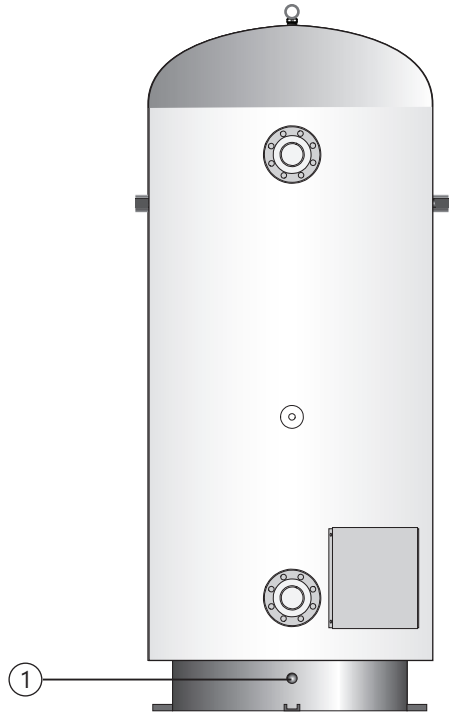

## 5. USER GUIDE

### 5.1 Settings (optional - heat accumulator only)

#### 5.1.1 Thermostat setting

The product thermostats are adjustable from 50-75°C. The thermostat should not be set lower than 65°C to prevent bacteria growth. To adjust the temperature:

- A) Disconnect the power supply.
- B) Remove the junction box cover (2).
- C) Adjust the temperature on the thermostats (3) with a screwdriver.

Refit the electric junction box cover (2) before connecting the power supply.

#### 5.1.2 Resetting the safety thermostat

The safety thermostats on the product cuts out when there is a risk of overheating. Thermostats are reset by switching off the power supply, removing the cover (2) and pressing the red 'RESET' button (4). If the thermostat cuts out repeatedly, contact the installer. Refit cover (2) before turning power on.

 <b>WARNING</b>
<p>Constant voltage is present in the junction box. Before any electrical work is done, the power supply must be disconnected and secured against activation while the work is in progress.</p>

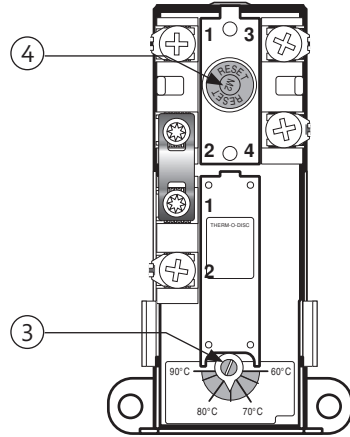

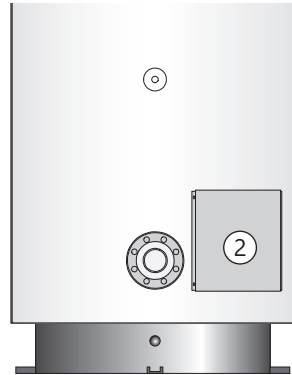

#### MANUFACTURER NOTIFICATION

The products shown in this manual is equipped with a standard nozzle layout. The product can however be designed entirely to customer specifications, and the product that is supplied with this manual may be specified with a different layout than the illustrations in the manual.



### 5.2 Maintenance

#### MAINTENANCE INSTRUCTIONS

	Maintenance should be carried out by persons over 18 years of age, with sufficient understanding.
	Annual inspection of safety valve:
-	Open valve for 1 min. by turning the knob (1) counterclockwise to the open position.
-	Visually check that the water is flowing freely to the drain.
-	YES = OK. Close the valve by turning knob (1) further clockwise until valve shuts.
-	NO = NOT OK. Disconnect power supply / shut off water supply. Contact installer.

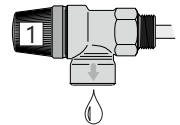

## 7. WARRANTY CONDITIONS

### 1. Scope

OSO Hotwater AS (hereinafter called OSO) warrants for 2 years from the date of purchase, that the Product will: i) conform to OSO specification, ii) be free from defects in materials and workmanship, subject to conditions below. All components carry a 2-year warranty.

The warranty is voluntarily extended by OSO to 5 years for the stainless steel inner tank. This extended warranty only applies to Products purchased by a consumer, that has been installed for private use and that has been distributed by OSO or by a distributor where the Products have been originally sold by OSO. The extended warranty does not apply to Products purchased by commercial entities or for Products that have been installed for commercial use. These shall be subject only to the mandatory provisions of the law. The conditions and limitations set out below shall apply.

### 2. Coverage

If a defect arises and a valid claim is received within the statutory warranty period, at its option and to the extent permitted by law, OSO shall either: i) repair the defect, or; ii) replace the product with a product that is identical or similar in function, or; iii) refund the purchase price.

If a defect arises and a valid claim is received after the statutory warranty period has expired, but within the extended warranty period, OSO will supply a product that is identical or similar in function. OSO will in such cases not cover any other associated costs.

Any exchanged Product or component will become the legal property of OSO. Any valid claim or service does not extend the original warranty. The replacement Product or part does not carry a new warranty.

### 3. Conditions

The Product is manufactured to suit most public water supplies. However, there are certain water chemistries (outlined below) that can have a detrimental effect on the Product and its life expectancy. If there are uncertainties regarding water quality, the local water supply authority can supply the necessary data.

The warranty applies only if the conditions set out below are met in full:

- The Product has been installed by a professional installer, in accordance with the instructions in the installation manual and all relevant Codes of Practice and Regulations in force at the time of installation.
- The Product has not been modified in any way, tampered with or subjected to misuse and no factory fitted parts have been removed for unauthorized repair or replacement.
- The Product has only been connected to a domestic mains water supply in compliance with the European Drinking Water Directive EN 98/83 EC, or latest version. The water

should not be aggressive, i.e. the water chemistry shall comply with the following:

- Chloride	< 250 mg / L
- Electric Conductivity (EC) @25°C	< 750 uS / cm
- Saturation Index (LSI) @80°C	> - 1,0 / < 0,8
- pH level	> 6,0 / < 9,5

- The immersion heater has not been exposed to hardness levels exceeding 10°dH (180 ppm CaCO<sub>3</sub>). A water softener is recommended in such cases.
- Any disinfection has been carried out without affecting the Product in any way whatsoever. The Product shall be isolated from any system chlorination.
- The Product has been in regular use from the date of installation. If the Product is not intended to be used for 60 days or more, it must be drained.
- Service and/or repair shall be done according to the installation manual and all relevant codes of practice. Any replacement parts used shall be original OSO spare parts.
- Any third-party costs associated with any claim has been authorized in advance by OSO in writing.
- The purchase invoice and/or installation invoice, a water sample as well as the defective product is made available to OSO upon request.

Failure to follow these instructions and conditions may result in product failure, and water escaping from the Product.

### 4. Limitations

The warranty does not cover:

- Any fault or costs arising from incorrect installation, incorrect application, lack of regular maintenance in accordance with the installation manual, neglect, accidental or malicious damage, misuse, any alteration, tampering or repair carried out by a non-professional, any fault arising from the tampering with or removal of any factory fitted safety components or measures.
- Any consequential damage or any indirect loss caused by any failure or malfunction of the Product whatsoever.
- Any pipework or any equipment connected to the Product.
- The effects of frost, lightning, voltage variation, lack of water, dry boiling, excess pressure or chlorination procedures.
- The effects of stagnant (de-aerated) water if the Product has been left unused for more than 60 days consecutively.
- Damage caused during transportation. Buyer shall give the carrier notice of such damage.
- Costs arising if the Product is not immediately accessible for servicing.

These warranties do not affect the Buyer's statutory rights.

- A) The installer who supplied the product.
- B) OSO Hotwater AS: Tel.: +47 32 25 00 00  
oso@oso.no / www.oso.no

### 7.1 Customer service

In case of problems that cannot be resolved with the aid of the troubleshooting guide in this installation manual, contact either:

## 8. REMOVING THE PRODUCT

### 8.1 Removal

- A) Disconnect the power supply.
- B) Shut off incoming cold water supply.
- C) Empty the product of water – see section 4.4.
- D) Disconnect all pipes.
- E) The product can now be removed.

### 8.2 Returns scheme

This product is recyclable and should be taken to the environmental recycling centre. If the product is to be replaced with a new one, the installer can take the old cylinder away for recycling.

# OSO

HOTWATER

**OSO Hotwater AS**

Industriveien 1  
3300 Hokksund - Norway  
Tel: + 47 32 25 00 00  
oso@oso.no  
www.osohotwater.com

© This installation manual and all its content is protected by copyright and may be reproduced or distributed only with written consent from the manufacturer. The manufacturer reserve the right to make changes without notice.